

# bellfires. gas fires

## User manual

Room Divider Large 3 CF/LF/MF

Room Divider Large 3 L/R CF/LF/MF



Serial number:

Production date:

© **Barbas Bellfires BV**

This document or parts thereof may not be reproduced, stored in a retrieval system, or transmitted, in any form or by any means, electronic, mechanical, photocopying, recording, nor otherwise, without the prior written permission of Barbas Bellfires BV. This document could contain technical inaccuracies or typographical errors. Barbas Bellfires BV reserves the right to revise this document from time to time in the contents thereof.

**Contact information**

Barbas Bellfires BV

Hallenstraat 17, 5531 AB Bladel, The Netherlands

Phone: +31 49 733 9200

E-mail: [info@bellfires.com](mailto:info@bellfires.com)

# Contents

<b>1</b>	<b>About this document.....</b>	<b>5</b>
1.1	How to work with this document.....	5
1.2	Warnings and cautions used in this document.....	5
1.3	Related documentation.....	5
<b>2</b>	<b>Description.....</b>	<b>6</b>
2.1	Intended use.....	6
2.2	Overview of the appliance.....	6
2.3	Overview of the remote control.....	7
2.3.1	Overview of the buttons.....	7
2.3.2	Overview of the display.....	8
2.4	Operation modes.....	9
2.4.1	Thermostatic mode.....	9
2.4.2	Program mode.....	9
2.4.3	Eco mode.....	9
2.4.4	Countdown timer mode.....	9
2.5	Overview of the control elements.....	10
2.5.1	Overview of the receiver.....	10
2.5.2	Overview of the light module (MF only).....	11
<b>3</b>	<b>Safety.....</b>	<b>12</b>
3.1	Safety devices on the appliance.....	12
3.2	Safety instructions for operation.....	12
3.3	Safety instructions with regard to the environment.....	13
<b>4</b>	<b>Operation.....</b>	<b>14</b>
4.1	Preparation before first use.....	14
4.1.1	Do a check on the appliance.....	14
4.1.2	Prepare the appliance.....	14
4.1.3	Connect the receiver with the remote control.....	14
4.1.4	Start the appliance.....	14
4.2	Set the remote control settings.....	15
4.2.1	Set the one/two-button operation.....	15
4.2.2	Set the temperature scale.....	15
4.2.3	Set the day and time.....	15
4.3	Operate the appliance.....	16
4.3.1	Operate the appliance.....	16
4.4	Change the settings.....	20
4.4.1	Set the temperature for the thermostatic mode.....	20
4.4.2	Set the program mode settings.....	20
4.4.3	Set the countdown timer mode.....	21

<b>5</b>	<b>Maintenance.....</b>	<b>22</b>
5.1	Maintenance schedule.....	22
5.2	Clean the appliance.....	22
5.3	Clean the glass.....	22
5.3.1	Cleaning instructions for anti-reflective glass.....	22
5.3.2	Cleaning instructions for standard glass.....	23
<b>6</b>	<b>Troubleshooting.....</b>	<b>24</b>
6.1	Troubleshooting table.....	24
6.2	Troubleshooting procedures.....	24
6.2.1	Replace the batteries of the remote control.....	24
<b>7</b>	<b>Technical data.....</b>	<b>26</b>
7.1	Room Divider Large 3 (L/R) MF (MagniFire).....	26
7.2	Room Divider Large 3 (L/R) CF (Centre Fire).....	27
7.3	Room Divider Large 3 (L/R) LF (Line Fire) .....	28
<b>8</b>	<b>Warranty Terms.....</b>	<b>30</b>
<b>9</b>	<b>EU-Declaration of Conformity.....</b>	<b>32</b>

# 1 About this document

This document shows the necessary information to do these tasks on the :

- Operate the appliance
- Do basic maintenance

This document refers to the as 'the appliance'. This document is an essential part of your appliance. Read it carefully before you do work on the appliance. Keep it in a safe place.

The original instructions of the document are in English. All other language versions of the document are translations of the original instructions. It is not always possible to provide a detailed illustration of every single item of the equipment. The illustrations in this document show a typical setup. The illustrations are for instructional use only.

## 1.1 How to work with this document

1. Make yourself familiar with the structure and content of the document.
2. Read the safety chapter in detail.
3. Make sure that you understand all the instructions.
4. Do the procedures completely and in the given sequence.

## 1.2 Warnings and cautions used in this document

### Warning



If you do not obey these instructions, there is a risk that can cause personal injury or death.

### Caution

If you do not obey these instructions, there is a risk of damage to the equipment or to property.

### Note

A note shows more information.

Symbol	Description
	Visual sign that there is a hazard
	Visual sign that there is a notice

## 1.3 Related documentation

- Preparation manual
- Installation and maintenance manual
- User manual

## 2 Description

### 2.1 Intended use

Only use the appliance to heat the room in which the appliance is installed. Do not use the appliance for a different purpose.

### 2.2 Overview of the appliance

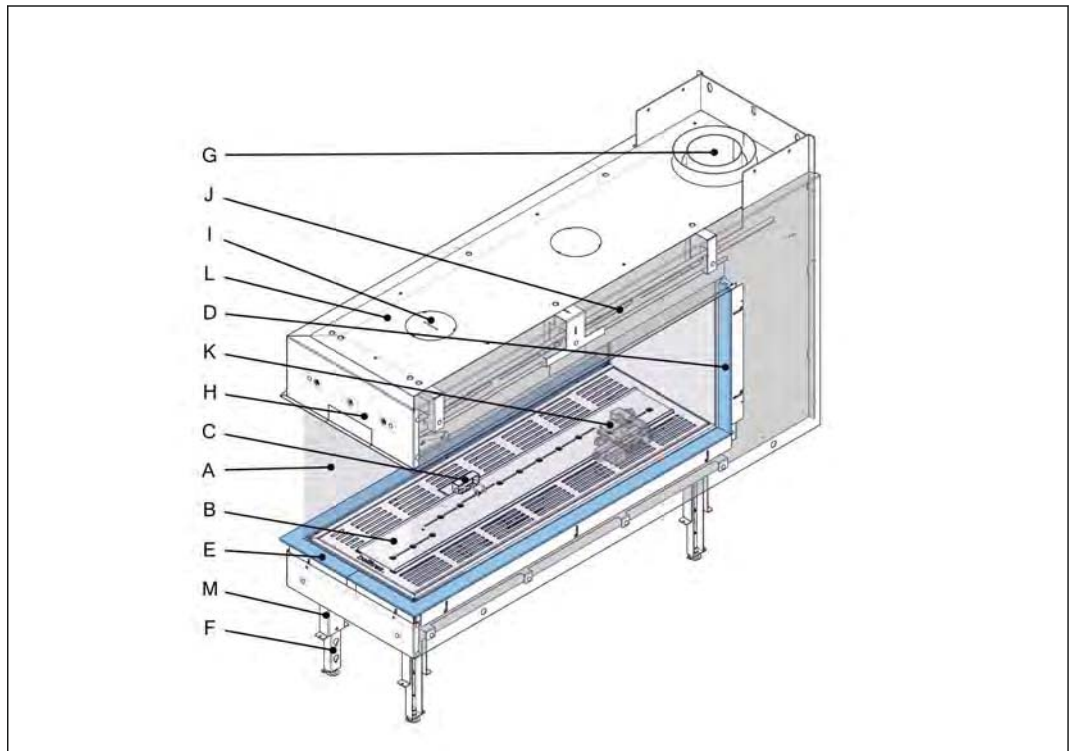

Item	Description
A	Glass The heat resistant glass keeps the flue gases inside the appliance and closes the combustion chamber off
B	Burner bed Top side of the gas burner and grate
C	Pilot light burner Provides a pilot light
D	Side panels 2 decorative steel panels on the left side and right side (not visible in the picture) of the appliance
E	Front panels 2 decorative steel panels surrounding the underside of the glass panels
F	Extended adjustable feet 4 adjustable feet at the bottom of the appliance (only for built-in installation)
G	Concentric flue connection The connection to the concentric flue system that provides combustion air and extracts the flue gases
H	Inlet opening convection air An inlet opening in the front of the appliance which is connected to the convection casing
I	Outlet opening convection air An outlet opening in the front of the appliance which is connected to the convection casing

	Item	Description
J	Overpressure hatches	Protects the appliance against an overpressure
K	Operating unit	Contains the gas regulator block, receiver and the light module
L	Convection casing	Collects the heated convection air. The convection air has a natural upward flow and is extracted by the upper front side openings of the appliance
M	Extended feet holder	4 extended feet holders for the extended adjustable feet (only for built-in installation)

## 2.3 Overview of the remote control



**Note:** The remote control is not interchangeable with a remote control from a different model.

You can operate the appliance with the remote control. The remote control communicates with the receiver.

### 2.3.1 Overview of the buttons

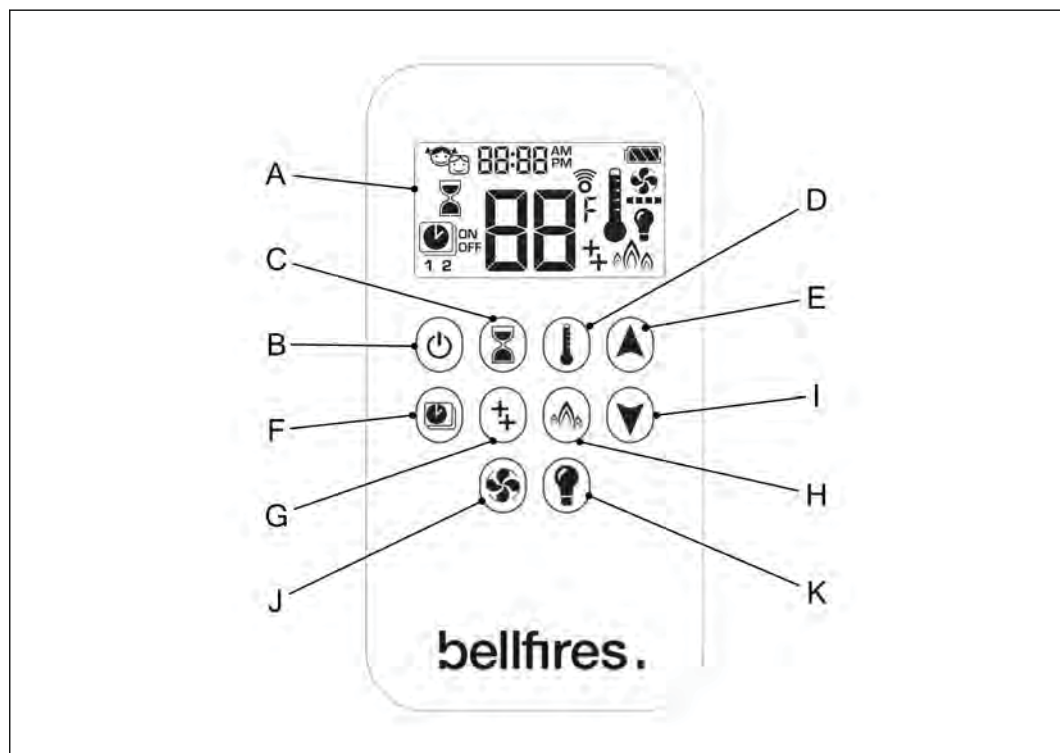

	Item	Description
A	Display	The display of the remote control.
B	On/off	To start and stop the appliance.
C	Countdown timer	To set to countdown timer mode.
D	Thermostatic mode	To set to thermostatic mode.
E	Up	To set different options.
F	Program mode	To set to program mode.

	Item	Description
G	Burner	To set the burner mode.
H	Eco mode	To set to eco mode.
I	Down	To set different options.
J	Fan (Not applicable)	To set to fan mode
K	Light (only for MF burner)	To set to light mode

## 2.3.2

## Overview of the display

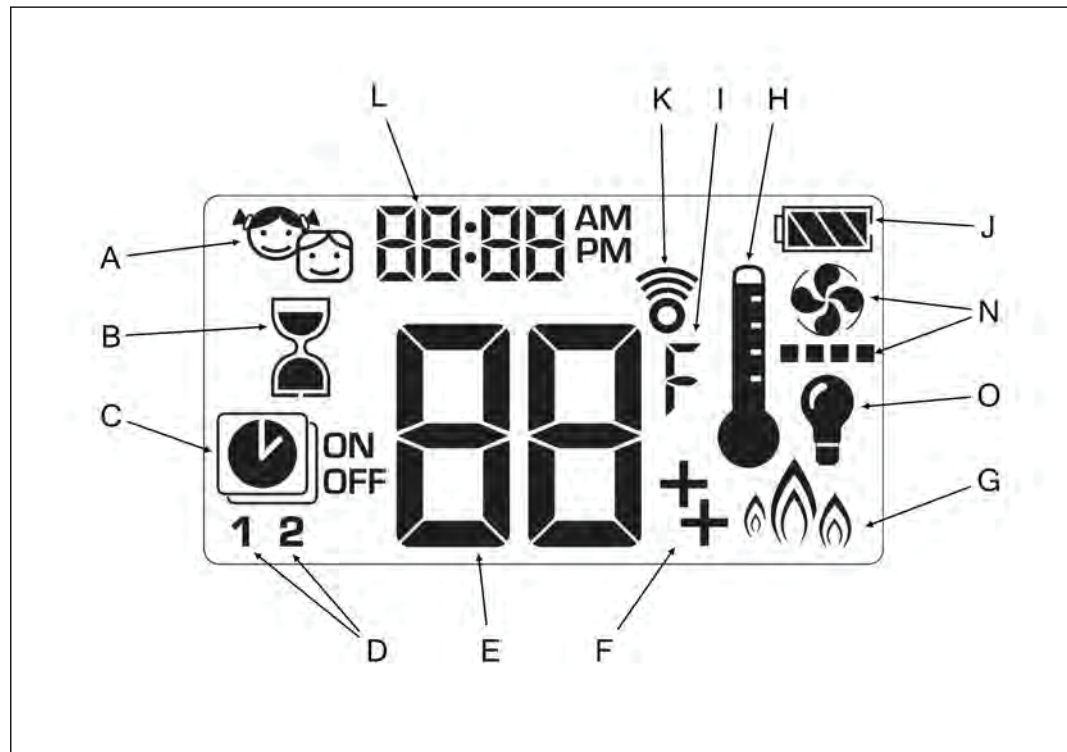

	Item	Description
A	Child proof	To show that the remote control is locked, so children cannot use it.
B	Countdown timer	To show that the countdown timer is set.
C	Program mode	To show that the program mode is set.
D	Program number	To show that program 1 or 2 is active
E	Temperature	To show the set temperature.
F	AUX function	To show that both burners are on.
G	Eco mode	To show that the eco mode is set.
H	Thermostatic mode	To show that the thermostatic mode is on.
I	Temperature scale	To show the temperature in °C or °F.
J	Battery status	To show the status of the battery.
K	Signal indicator	To show if the signal is sent to the receiver.
L	Time	To show the current time.
M	Fan symbol (Not applicable)	To show that the fan is on
N	Fan speed symbol (Not applicable)	To show the fan speed level: one to four bars



---

	Item	Description
O	Light symbol (only for MF burner)	To show that the light is on

## 2.4 Operation modes

### 2.4.1 Thermostatic mode

In this mode the appliance measures the room temperature and compares this to the set temperature. The appliance automatically adjusts the flame height to make sure that the room temperature agrees with the set temperature.

### 2.4.2 Program mode

In this mode you can set two different programs. You can use these programs to start and stop the appliance at a set temperature on specific times and days.

### 2.4.3 Eco mode

In this mode the flame height changes between minimum and maximum height for the duration of a cycle:

- If the room temperature is lower than the set temperature, the flame height will stay high for a longer period of time.
- If the room temperature is higher than the set temperature, the flame height will stay low for a longer period of time.

A cycle in the eco mode continues for approximately 20 minutes.

### 2.4.4 Countdown timer mode

In this mode you can set a period of time after which the appliance stops. The countdown timer mode only operates when the appliance is set to the manual, thermostatic or eco mode.

## 2.5 Overview of the control elements

### 2.5.1 Overview of the receiver

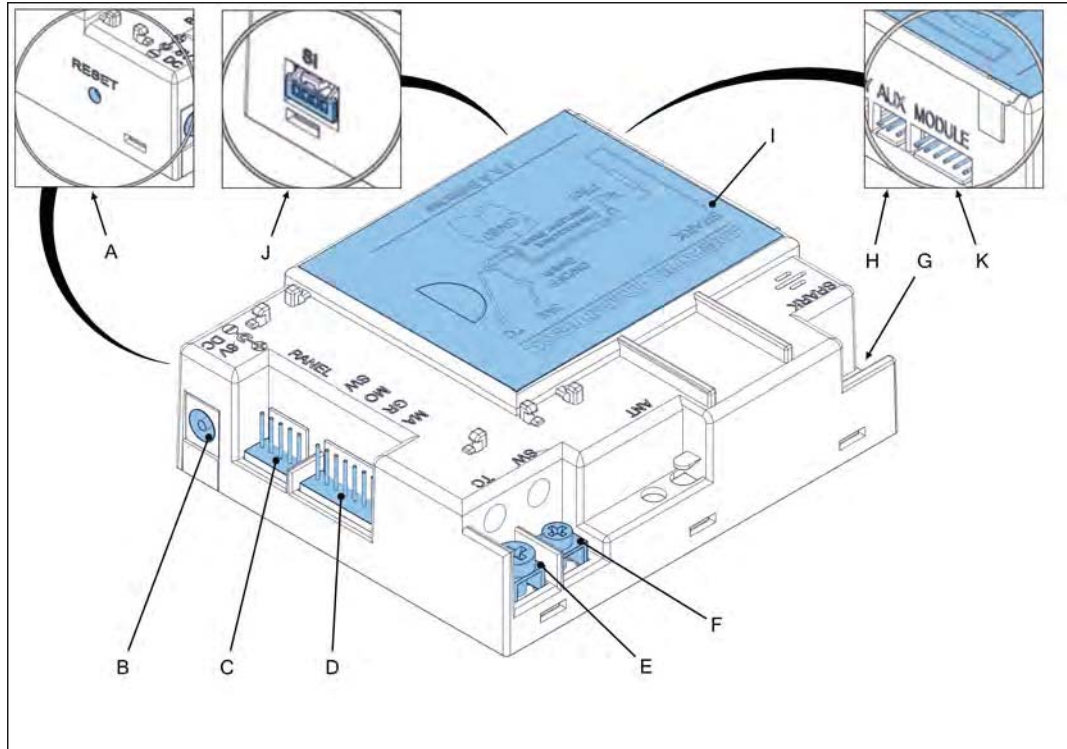

Item	Description
A	Reset button Reset of the receiver
B	Connection for an adapter Optionally, a 6 VDC adapter can supply the receiver and an optional wifi-box with power
C	connection for external operating Optionally, a wall switch or domotica system can be connected
D	8 wire cable connection Sends signals to the gas regulator block
E	Thermocouple voltage / current IN (red connection) Connection to the thermoelectric pilot light shut-off wire IN
F	Thermocouple voltage / current OUT (yellow connection) Connection to the thermoelectric pilot light shut-off wire OUT
G	Piezo cable connection Connection for the piezo cable which is connected to the ignition electrode of the pilot light
H	Connection to the gas valve rear burner (AUX) Sends a signal if the rear burner must burn
I	Battery compartment cover Batteries are not applicable in the receiver for this appliance. (Power is supplied by the fan/ light module.)
J	Connection for a wifi-box (SI) Optionally, a wifi-box can be connected to the receiver to control the appliance with a smart-phone or tablet with the Bellfires app
K	Connection for the light module (MODULE) (only for MF burner) To control the light function

2.5.2 Overview of the light module (MF only)

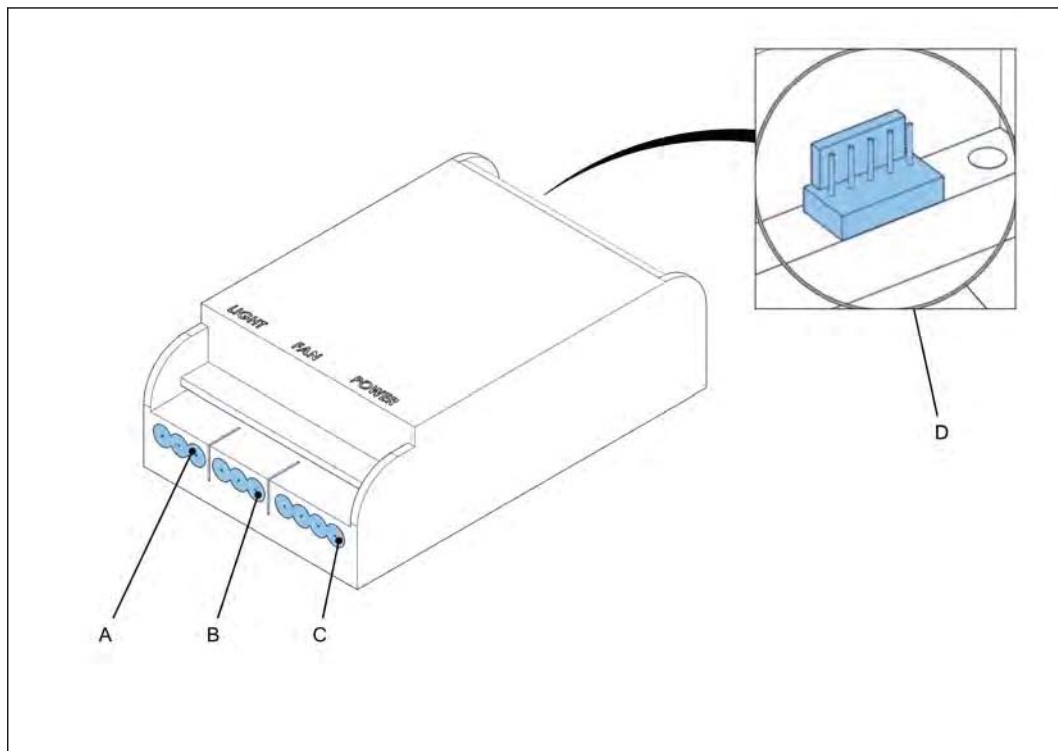

	Item	Description
A	Connection for the ambient lights	Powers the ambient light bulbs
B	Auxiliary connection	Not used
C	connection for the power supply	Connection for the 230 VAC power cable with an earthed plug. Connection is also used for earthing the appliance
D	Connection for the receiver	To control the light function

## 3 Safety

### 3.1 Safety devices on the appliance

Name	Description
Thermo-electric pilot light shut off	Prevents unforeseen discharge of gas from the main burner.
Overpressure door (= glass front) and overpressure hatch	If an overpressure occurs in the appliance, the glass front door and the hatch opens for a short duration. When the door and hatch opens, a loud noise can occur. If an overpressure occurs, the installer must do a thorough check on the appliance.

### 3.2 Safety instructions for operation



#### Warning:

- Do not put flammable items within 100 cm of the appliance.
- Do not use the appliance when the glass is removed.
- Do not use flammable fuels on the ceramic logs.
- Make sure that children are supervised when they can reach the appliance.
- Use a fire screen for heat protection.
- Make sure that there is sufficient ventilation in the room in which the appliance is installed.
- Do not use the appliance in case of visual glass damage.
- Make sure that the appliance is installed correctly. Refer to the Installation and Maintenance manual. You can find the manuals on <http://bellfires.com>.
- Make sure that the appliance is installed and connected as a 'room sealed system' appliance by a certified and registered gas installation engineer.



#### Caution:

- Make sure that embers, vermiculite granules, ceramic logs or pebbles do not touch the pilot light burner.
- Make sure that the pilot light burner is not blocked.
- Do not adjust the position of embers, vermiculite granules, ceramic logs or pebbles on the main burner.
- Keep the remote control in a dry and cool place away from direct sunlight.
- Clean the glass when it is dirty. If the glass is not cleaned when it is dirty the glass can become permanently dull.
- Make sure that the yearly maintenance is done.
- Do not use the appliance for 4 weeks after installation. This time is necessary for the building materials to set.



#### Note:

- If you do not use the appliance for an extended period of time, close the gas supply.
- We recommend to set the appliance to stand-by mode (only the pilot light burns) during winter to prevent condensation in the appliance.

### 3.3 **Safety instructions with regard to the environment**

- Dispose of the packing materials in an environmentally friendly way.
- Dispose of batteries as chemical waste.
- Dispose of ceramic heat-resistant glass as household waste. Do not dispose of ceramic heat-resistant glass in a glass recycling container.
- Dispose of an obsolete appliance according to instructions of the authorities or the fitter.
- Obey the local regulations.

## 4 Operation

### 4.1 Preparation before first use

#### 4.1.1 Do a check on the appliance

1. Make sure that the appliance is not damaged.
2. Make sure that the glass is not damaged.
3. Make sure that the pilot light operates correctly.

#### 4.1.2 Prepare the appliance



**Warning:**

- Do not use the appliance for 4 weeks after installation. This time is necessary for the building materials to set.
- Make sure that there is sufficient ventilation in the room in which the appliance is installed.



**Note:** The appliance has a heat-resistant coating. When you use the appliance for the first time, the coating can cause an unpleasant, but harmless smell.

1. Start the appliance, refer to section [4.3](#).
2. Set the flame height to maximum, refer to [4.3](#).
3. Keep the flame height to maximum for 10 minutes to make sure the chimney becomes warm.
4. Use the appliance with maximum flame height for several hours to remove the smell of the coating.
5. When the appliance is cool, clean the appliance. Refer to [5.2](#).

#### 4.1.3 Connect the receiver with the remote control



**Note:**

- You only have to connect the receiver once. Even when you change the batteries, the remote control stores the settings.

1. On the receiver, push and hold the reset button until you hear two beeps.
2. Within 20 seconds of the second beep, push and hold the down button on the remote control until you hear two short beeps. If you hear one long beep the receiver is not set, try again.  
The receiver is connected.

#### 4.1.4 Start the appliance



**Warning:**

- Keep a minimum distance of 100 cm of the appliance when you start the pilot light.
- When the pilot light goes out, always wait 5 minutes before you start it again.



**Note:**

- The main burner burns at maximal height after start-up.
  - If the pilot light goes out and you start the appliance too early, the remote control will start but the fire will not burn. Restart the remote control.
- Start the appliance with the on/off button(s). Refer to [4.3](#).

## 4.2 Set the remote control settings

### 4.2.1 Set the one/two-button operation

- When the display shows '1', the one-button operation mode is selected.
- When the display shows '2', the two-button operation mode is selected. This mode will prevent accidental start-up of the appliance.

1. Remove the batteries from the remote control.
2. Put the batteries in the remote control. The screen starts to blink.
3. Push and hold the on/off button for approximately 10 seconds. The current setting of the remote starts to blink.
4. When the number changes and stops to blink, release the button.
  - The '1' changes into '2' when the remote control is set to the two-button operation.
  - The '2' changes into '1' when the remote control is set to the one-button operation.

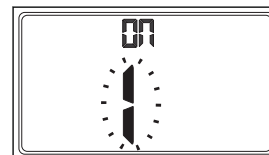
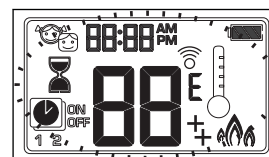

### 4.2.2 Set the temperature scale

- If you set the temperature scale to °C, the display shows a 24-hour clock.
- If you set the temperature scale to °F, the display shows a 12-hour clock.
- Push the on/off button and the countdown timer button at the same time to change the temperature scale between °C and °F.









### 4.2.3 Set the day and time

1. Push the up and down buttons at the same time. The day flashes in the display.
2. Use the up and down buttons select the day of the week (1 for Monday, 2 for Tuesday etc.).
3. Push the up and down buttons at the same time. The hour flashes in the display.
4. Use the up and down buttons to select the hour.
5. Push the up and down buttons at the same time. The minutes flash in the display.
6. Use the up and down buttons to select the minutes.
7. Push the up and down buttons at the same time to store the day and time settings.





## 4.3 Operate the appliance

### 4.3.1 Operate the appliance

**Table 1: Start and stop the appliance**

Action	Preconditions	Steps	Result
Start the appliance with one-button operation	The remote control is set to the one-button operation. Refer to section 4.2.1.	Push 	<ul style="list-style-type: none"> <li>You hear a short beep.</li> </ul> 
Start the appliance with two-button operation	The remote control is set to the two-button operation. Refer to section 4.2.1.	Push  and  at the same time	<ul style="list-style-type: none"> <li>You can use the remote control when the main screen shows</li> </ul> 
Start the appliance from stand-by mode	The appliance is set to stand-by mode.	Push and hold 	
Stop the appliance		Push 	

**Table 2: Set the appliance to different modes**

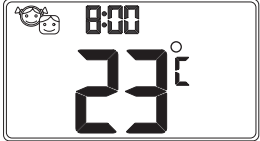
Action	Preconditions	Steps	Result
Set the appliance to stand-by mode		Push and hold  until only the pilot light burns	
Start the child proof mode		Push  and  at the same time	<p>You can only use the off function of the remote control.</p> 





















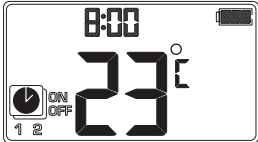



Action	Preconditions	Steps	Result
Stop the child proof mode		Push  and  at the same time	
Start the thermostatic mode		Push 	
Stop the thermostatic mode		Push 	
Start the program mode		Push 	
Stop the program mode		Push 	
Start the eco mode		Push 	
Stop the eco mode		Push 	
Start the countdown timer mode		Push 	
Stop the countdown timer mode		Push 	

Table 3: Start and stop the rear burner











**Note:** When you start the appliance the front burner is on and the rear burner is set to the last setting. The rear burner is always set to the last selected setting, even when the batteries of the receiver are empty.

Action	Preconditions	Steps	Result
Start the rear burner		Push 	
Stop the rear burner		Push 	

**Table 4: Adjust the flame height**



**Note:** When you start the appliance the flame height is automatically set to maximum.

Action	Preconditions	Steps	Result
Decrease the flame height		Push and hold  until you have the desired flame height	
Increase the flame height		Push and hold  until you have the desired flame height	
Set the flame height to maximum	The background lighting is on.	Tap  twice	
Set the flame height to minimum	The background lighting is on.	Tap  twice	











**Table 5: Start and stop the light and adjust the brightness (only available for MF burner)**



**Note:** The Light works independently of the Pilot flame.



**Note:** If the main burner and pilot light are switched off, with button , the light will switch off automatically.

Action	Preconditions	Steps	Result
Start the light	Possible when the fire is on or off.	Push 	
Stop the light		Push 	
Decrease the light brightness	The light symbol is on.	<ul style="list-style-type: none"> <li>Push and hold  until the light symbol flashes</li> <li>Push and hold  until you have the desired light brightness</li> </ul>	
Increase the light brightness	The light symbol is on.	<ul style="list-style-type: none"> <li>Push and hold  until the light symbol flashes</li> <li>Push and hold  until you have the desired light brightness</li> </ul>	



**Note:**

Maximum thermostat 60°C.: The receiver in the appliance is fitted with a 60°C maximum thermostat. When this thermostat is activated, the main burner will be completely switched off and the pilot light will continue to burn. The convection fan will then automatically switch to the highest setting and continue to run for a maximum of 10 minutes. The temperature in the receiver is measured every minute. The appliance cannot be operated again until the temperature has returned to below 60°C.



**Note:**

To save energy, the pilot-flame automatically extinguishes when the appliance is not used for a period of 5 days.

## 4.4 Change the settings

### 4.4.1 Set the temperature for the thermostatic mode

1. Push and hold the thermostatic mode button until the thermostatic mode symbol appears and the temperature flashes.
2. Use the up and down buttons to set the temperature.
3. Push the thermostatic mode button to store the temperature or wait until the temperature stops to flash.



### 4.4.2 Set the program mode settings



**Note:**

- The temperature for the starting time in the program mode is the same as the temperature that is set in the temperature mode.
- The set temperatures for the starting and stopping times of the appliance are the same for each day.
- When the batteries are removed from the remote control, the set temperatures, days and times are reset.

Default settings:

- Temperature when the appliance starts: 21 °C (70 °F).
- Temperature when the appliance stops: "--" (pilot light only).

1. Push and hold the program mode button until the program mode flashes and 'ON' and the set temperature appears.
2. Tap the program mode button to continue. The display of the remote control shows 'OFF' and the temperature flashes.
3. Use the up and down buttons to set the temperature for the stopping time of the appliance.
4. Push the program mode button to store the temperature and to continue.
5. Use the up and down buttons to set the day(s) the program is active.

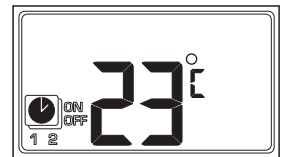

**Note:**

'ALL' (every day), 'SA:SU' (saturday and sunday), '1' (monday), '2' (tuesday), '3' (wednesday), '4' (thursday), '5' (friday), '6' (saturday) or '7' (sunday).

6. Push the program mode button to store the day.
7. Use the up and down buttons to select the hour on which the appliance starts up.
8. Push the program mode button to store the hour.
9. Select the minutes on which the appliance starts up and push the program mode button.
10. Select the hour and minutes for the stop time of the appliance.
11. If you do not want program 2 active in program mode, wait for the blinking to stop to save the settings.

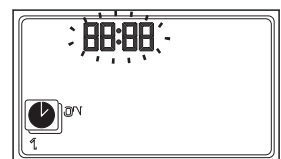
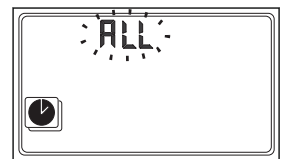

12. If you want program 2 active, push the program mode button and set the on and off time for program 2.
13. Wait for the blinking to stop to save the settings.

#### 4.4.3 Set the countdown timer mode



**Note:** The maximum period of time you can set for this mode is 9 hours and 50 minutes.

1. Push and hold the countdown timer button until the display shows the countdown timer symbol and the hour flashes.
2. Use the up and down buttons to select the number of hour.
3. Push the countdown timer button to store the hour. The minutes flash on the display.
4. Use the up and down buttons to select the number of minutes.
5. Push the countdown timer button to store the minutes.
6. Push the countdown timer button to confirm the countdown or wait.



## 5 Maintenance

### 5.1 Maintenance schedule



**Caution:**

Clean the glass when it is dirty. If the glass is not cleaned when it is dirty the glass can become permanently dull.

Task	Frequency	Procedure
Clean the appliance	Daily	Refer to section <a href="#">5.2</a>
Maintenance by your fitter	Yearly	Refer to your fitter/dealer

### 5.2 Clean the appliance



**Note:**

- Use gloves to avoid visible fingerprints on the glass.
- If you use a vacuum lifter to remove the glass, make sure that the suction pads are clean and dry. If the suction pads are not clean or dry, the suction pads can leave a mark.

1. Make sure that the appliance is off and is cooled down.
2. Remove any dust from the operating unit. Use a vacuum cleaner.
3. Do a check on the glass for damage. If you see damage, replace the glass. Do not use the appliance before the glass is replaced. For disposal of the glass, refer to [3.3](#).
4. Clean the glass.
  - a) If the inner side is dirty, remove the glass. Refer to the Installation and maintenance manual.
  - b) Clean the glass, refer to [5.3](#).
  - c) Install the glass. Refer to the Installation and maintenance manual.

### 5.3 Clean the glass

Make sure to know which type of glass is in your appliance.

To clean anti-reflective glass refer to chapter '[5.3.1](#)'.

To clean standard glass refer to chapter '[5.3.2](#)'.

#### 5.3.1 Cleaning instructions for anti-reflective glass



**Caution:**

- Do not use hard sponges, steel wool, abrasives and cleaning agents containing ammonia.
- Do not use caustic products and products containing abrasives, such as ceramic hob cleaners.
- Do not use paper tissues.

1. Use gloves to prevent fingerprints on the glass.
2. Make sure to use a neutral cleaning agent.
3. Clean the glass with a soft cloth or sponge.
4. Make sure the glass is dry. Water droplets can leave a mark on the glass.

**5.3.2 Cleaning instructions for standard glass**

1. Use gloves to prevent fingerprints on the glass.
2. Clean the glass with a soft cloth, a sponge or tissue paper. Use glass cleaner or ceramic hob cleaner.
3. Make sure the glass is dry. Water droplets can leave a mark on the glass.

## 6 Troubleshooting

### 6.1 Troubleshooting table

Problem	Possible cause	Possible solution
The pilot light does not come on after three attempts.		<ul style="list-style-type: none"> <li>• Close the gas supply</li> <li>• Contact your fitter.</li> </ul>
The burner does not operate within 10 seconds of firing the pilot light.		
When the burner starts you hear a 'boom' sound.		
You hear a loud noise when the overpressure door (= glass front) and overpressure hatch opens.		
You hear a continuous beep for five seconds.	One of the cables is disconnected.	Contact to your fitter.
The appliance does not start.	The gas supply is off.	Open the gas supply.
The battery status of the remote control is empty	The batteries of the remote control are empty.	Replace the batteries of the remote control. Refer to section <a href="#">6.2.1</a> .
The appliance does not respond to the remote control.	The batteries of the remote control are empty.	
	The system has a failure.	
	There is no power supply (230 VAC).	Repair the power supply.
The appliance regularly stops for no reason.		Contact your fitter.
The glass is broken or cracked		Replace the glass. For disposal of the glass refer to <a href="#">3.3</a> .
The lacquer of the appliance is damaged		Contact your fitter.

### 6.2 Troubleshooting procedures

#### 6.2.1 Replace the batteries of the remote control



**Caution:**

- Only replace the batteries when the appliance is off.
- If you put the batteries in an incorrect position, this can cause damage to the electrical connections.
- Do not use rechargeable batteries.



**Note:**

We recommend the use of alkaline batteries.



1. Remove the cover of the remote control.
2. Remove all batteries.
3. Install new batteries. For approved batteries, refer to section 7.
4. Close the cover of the remote control.

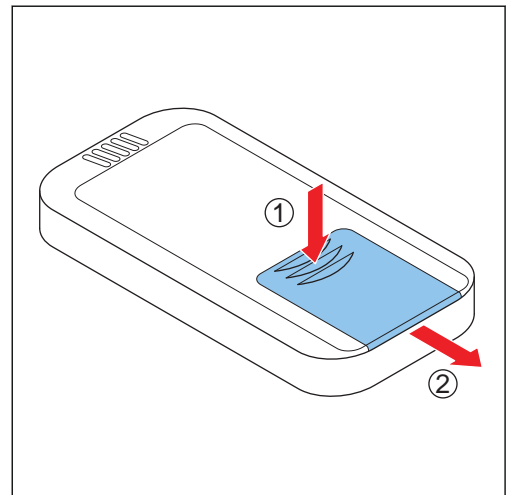

## 7 Technical data

### 7.1 Room Divider Large 3 (L/R) MF (MagniFire)

	Natural gas	Butane/ Propane
Name	Belfires	Belfires
Model	Room Divider Large 3 MF Room Divider Large 3 L/R MF	Room Divider Large 3 MF Room Divider Large 3 L/R MF
Country	GB, IE, ES, IT	GB, IE, ES, IT
Product identification no	0063CM3684	0063CM3684
Indirect heating functionality	No	No
Type of appliance under CE-norm	C <sub>11</sub> / C <sub>31</sub> / C <sub>91</sub>	C <sub>11</sub> / C <sub>31</sub> / C <sub>91</sub>
Category of appliance	I <sub>2H</sub> natural gas G20	I <sub>3B/P</sub> butane/propane G30/G31
Energy efficiency class	A	A
Energy efficiency index (EEI)	88.2	88.2
Nominal heat input (Gross calorific value)	11.1 kW	Butane (G30) : 10.0 kW Propane (G31) : 8.9 kW
Nominal heat output	10.0 W	Butane (G30) : 9.3 kW Propane (G31) : 8.1 kW
Minimum heat output (indicative)	4.5 kW	Butane (G30) : 4.0 kW Propane (G31) : 2.8 kW
Useful efficiency (Net Calorific Value (NCV)) at nominal heat output	90.4 %	90.8 %
Useful efficiency (Net Calorific Value (NCV)) at minimum heat output (indicative)	85.8%	86.6 %
NO <sub>x</sub> (max.) (Gross Calorific Value (GCV))	<130 mg/kWh <sub>input</sub>	<130 mg/kWh <sub>input</sub>
NO <sub>x</sub> class	4	4
Gas rate (max.)	1.04 m <sup>3</sup> /hr.	Butane (G30) : 750 gr/hr. Propane (G31) : 650 gr/hr.
Supply pressure	20.0 mbar	Butane (G30) : 37.0 mbar Propane (G31) : 37.0 mbar
Batteries remote control receiver	None	None
batteries remote control hand transmitter	2x 1.5V AAA	2x 1.5V AAA
Electrical connection	230 VAC / 50 Hz	230 VAC / 50 Hz
Auxiliary electricity consumption at nominal heat output	0.05 kW	0.05 kW
Auxiliary electricity consumption at minimum heat output	0 kW	0 kW
Auxiliary electricity consumption in standby mode	0 kW	0 kW

	Natural gas	Butane/ Propane
The specific precautions that shall be taken when the local space heater is assembled, installed or maintained, are listed in the attached documents:	<ul style="list-style-type: none"> <li>• Preparation manual</li> <li>• Installation and maintenance manual</li> <li>• User manual</li> </ul>	<ul style="list-style-type: none"> <li>• Preparation manual</li> <li>• Installation and maintenance manual</li> <li>• User manual</li> </ul>

(\*) Both burners at maximum. Appliance is on temperature.

(\*\*) Both burners at maximum. Appliance is cold.

(\*\*\*) Both burners at minimum.

Heat changing surface: Entire front of the appliance.

## 7.2 Room Divider Large 3 (L/R) CF (Centre Fire)

	Natural gas	Butane/ Propane
Name	Bellfires	Bellfires
Model	Room Divider Large 3 CF Room Divider Large 3 L/R CF	Room Divider Large 3 CF Room Divider Large 3 L/R CF
Country	GB, IE, ES, IT	GB, IE, ES, IT
Product identification no	0063CM3684	0063CM3684
Indirect heating functionality	No	No
Type of appliance under CE-norm	C <sub>11</sub> / C <sub>31</sub> / C <sub>91</sub>	C <sub>11</sub> / C <sub>31</sub> / C <sub>91</sub>
Category of appliance	I <sub>2H</sub> natural gas G20	I <sub>3B/P</sub> butane/propane G30/G31
Energy efficiency class	A	A
Energy efficiency index (EEI)	90.5	90.5
Nominal heat input (Gross calorific value)	12.0 kW	Butane (G30) : 11.2 kW Propane (G31) : 9.4 kW
Nominal heat output	9.2 kW	Butane (G30) : 8.6 kW Propane (G31) : 7.2 kW
Minimum heat output (indicative)	2.8 kW	Butane (G30) : 2.3 kW Propane (G31) : 1.8 kW
Useful efficiency (Net Calorific Value (NCV)) at nominal heat output	92.5 %	91.2 %
Useful efficiency (Net Calorific Value (NCV)) at minimum heat output (indicative)	87.5%	86.2 %
NO <sub>x</sub> (max.) (Gross Calorific Value (GCV))	<130 mg/kWh <sub>input</sub>	<130 mg/kWh <sub>input</sub>
NO <sub>x</sub> class	4	4
Gas rate (max.)	1.14 m <sup>3</sup> <sub>s</sub> /hr.	Butane (G30) : 860 gr/hr. Propane (G31) : 710 gr/hr.
Supply pressure	20.0 mbar	Butane (G30) : 37.0 mbar Propane (G31) : 37.0 mbar

	Natural gas	Butane/ Propane
Batteries remote control receiver	None	None
batteries remote control hand transmitter	2x 1.5V AAA	2x 1.5V AAA
Electrical connection	230 VAC / 50 Hz	230 VAC / 50 Hz
Auxiliary electricity consumption at nominal heat output	0 kW	0 kW
Auxiliary electricity consumption at minimum heat output	0 kW	0 kW
Auxiliary electricity consumption in standby mode	0 kW	0 kW
The specific precautions that shall be taken when the local space heater is assembled, installed or maintained, are listed in the attached documents:	<ul style="list-style-type: none"> <li>• Preparation manual</li> <li>• Installation and maintenance manual</li> <li>• User manual</li> </ul>	<ul style="list-style-type: none"> <li>• Preparation manual</li> <li>• Installation and maintenance manual</li> <li>• User manual</li> </ul>

(\*) Both burners at maximum. Appliance is on temperature.

(\*\*) Both burners at maximum. Appliance is cold.

(\*\*\*) Both burners at minimum.

Heat changing surface: Entire front of the appliance.

### 7.3 Room Divider Large 3 (L/R) LF (Line Fire)

	Natural gas	Butane/ Propane
Name	Bellfires	Bellfires
Model	Room Divider Large 3 LF Room Divider Large 3 L/R LF	Room Divider Large 3 LF Room Divider Large 3 L/R LF
Country	GB, IE, ES, IT	GB, IE, ES, IT
Product identification no	0063CM3684	0063CM3684
Indirect heating functionality	No	No
Type of appliance under CE-norm	C <sub>11</sub> / C <sub>31</sub> / C <sub>91</sub>	C <sub>11</sub> / C <sub>31</sub> / C <sub>91</sub>
Category of appliance	I <sub>2H</sub> natural gas G20	I <sub>3B/P</sub> butane/propane G30/G31
Energy efficiency class	A	A
Energy efficiency index (EEI)	89.2	89.2
Nominal heat input (Gross calorific value)	12.3 kW	Butane (G30) : 12.2 kW Propane (G31) : 10.1 kW
Nominal heat output	9.4 kW	Butane (G30) : 9.4 kW Propane (G31) : 7.8 kW
Minimum heat output (indicative)	3.3 kW	Butane (G30) : 2.5 kW Propane (G31) : 2.1 kW
Useful efficiency (Net Calorific Value (NCV)) at nominal heat output	91.2 %	93.3 %

	Natural gas	Butane/ Propane
Useful efficiency (Net Calorific Value (NCV)) at minimum heat output (indicative)	86.2 %	88.3 %
NO <sub>x</sub> (max.) (Gross Calorific Value (GCV))	<130 mg/kWh <sub>input</sub>	<130 mg/kWh <sub>input</sub>
NO <sub>x</sub> class	4	4
Gas rate (max.)	1.17 m <sup>3</sup> <sub>g</sub> /hr.	Butane (G30) : 930 gr/hr. Propane (G31) : 760 gr/hr.
Supply pressure	20.0 mbar	Butane (G30) : 37.0 mbar Propane (G31) : 37.0 mbar
Batteries remote control receiver	None	None
batteries remote control hand transmitter	2x 1.5V AAA	2x 1.5V AAA
Electrical connection	230 VAC / 50 Hz	230 VAC / 50 Hz
Auxiliary electricity consumption at nominal heat output	0 kW	0 kW
Auxiliary electricity consumption at minimum heat output	0 kW	0 kW
Auxiliary electricity consumption in standby mode	0 kW	0 kW
The specific precautions that shall be taken when the local space heater is assembled, installed or maintained, are listed in the attached documents:	<ul style="list-style-type: none"> <li>• Preparation manual</li> <li>• Installation and maintenance manual</li> <li>• User manual</li> </ul>	<ul style="list-style-type: none"> <li>• Preparation manual</li> <li>• Installation and maintenance manual</li> <li>• User manual</li> </ul>

(\*) Both burners at maximum. Appliance is on temperature.

(\*\*) Both burners at maximum. Appliance is cold.

(\*\*\*) Both burners at minimum.

Heat changing surface: Entire front of the appliance.

---

## 8 Warranty Terms

---

### **Barbas Bellfires Warranty Terms**

Barbas Bellfires B.V. guarantees the quality of the supplied Bellfires appliance and the quality of the materials used. All Bellfires appliances are developed and manufactured according to the highest possible quality standards. If, despite all this, something should prove amiss with the Bellfires appliance you have purchased, Barbas Bellfires B.V. offers the following manufacturer's warranty.

#### **Article 1: Warranty**

1. If Barbas Bellfires B.V. determines that the Bellfires appliance you have purchased is defective as a result of a flaw in the construction or material, Barbas Bellfires B.V. guarantees to repair or replace the appliance free of charge, without charging any costs for labour or spare parts.
2. Repair or replacement of the Bellfires appliance will be undertaken by Barbas Bellfires B.V. or by a Bellfires dealer as designated by Barbas Bellfires B.V.
3. This warranty is supplementary to the existing legal national warranty of Bellfires dealers and Barbas Bellfires B.V. in the country of purchase and is not intended to restrict your rights and claims based on the applicable legal provisions.

#### **Article 2: Warranty conditions**

1. Should you wish to claim under the warranty, please contact your Bellfires dealer.
2. Complaints should be reported as quickly as possible after they have manifested themselves.
3. Complaints will only be accepted if they are reported to the Bellfires dealer, together with the serial number of the Bellfires appliance which is stated on the front of the user manual.
4. In addition, the original receipt (invoice, receipt, cash receipt) showing the date of purchase must also be submitted.
5. Repairs and replacements during the warranty period do not give any entitlement to an extension of the warranty period. After a repair or replacement of warranty parts, the warranty period shall be deemed to have started on the date of purchasing the Bellfires appliance.
6. If a certain part is eligible for the warranty and the original part is no longer available, Barbas Bellfires B.V. shall ensure that an alternative part of at least the same quality shall be provided.

#### **Article 3: Warranty exclusions**

1. The warranty on the Bellfires appliance ceases to be in effect if:
  - a. it is not installed according to the supplied installation instructions, and to national and/or local regulations;
  - b. it has been installed, connected or repaired by a non-Bellfires dealer;
  - c. it has not be used or maintained according to the instructions for use;
  - d. it has been changed, neglected or roughly treated;
  - e. it has been damaged as a result of external causes (outside the hearth itself), for example, lightning strike, water damage or fire;
2. In addition, the warranty lapses if the original purchase receipt shows any change, deletion, removal or if it is illegible.

**Article 4: Warranty area**

1. The warranty is only valid in those countries where Bellfires appliances are sold through an official dealer network.

**Article 5: Warranty period**

1. This warranty will only be granted during the warranty period.
2. The body of the Bellfires appliance is guaranteed for a period of 10 years against construction and/or material faults, starting from the moment of purchase.
3. For other parts of the Bellfires appliance, a similar warranty applies from the moment of purchase for a period of two years.
4. For user parts such as glass, glass (cord), thermocouple and the interior of the combustion chamber, a similar guarantee is given until after the first burning.

**Article 6: Liability**

1. A claim granted by Barbas Bellfires B.V. under this warranty does not automatically imply that Barbas Bellfires B.V. also accepts liability for any possible damage. The liability of Barbas Bellfires B.V. never extends further than that stated in these warranty conditions. Any liability of Barbas Bellfires B.V. for consequential damage is expressly excluded.
2. That stated in this provision is not valid if and to the extent that it derives from a mandatory provision.
3. All agreements entered into by Barbas Bellfires B.V. are, unless specifically stated otherwise in writing and to the extent that they are permitted based on applicable law, subject to the FME-CWM general sales and delivery conditions for the technology industry.

Barbas Bellfires B.V.  
Hallenstraat 17 5531 AB Bladel  
The Netherlands  
Tel: +31-497339200  
Email: [info@Bellfires.com](mailto:info@Bellfires.com)

Carefully retain the user manual; it shows the serial number of the appliance. You will need this if you wish to claim under the warranty.

**9 EU-Declaration of Conformity**

**barbas bellfires.** fireplaces

**EU-Declaration of Conformity**

We

**Manufacturer:** Barbas Bellfires  
**Address:** Hallenstraat 17  
 5531 AB Bladel, The Netherlands  
**Phone:** +31 497 339 200  
**email:** info@barbasbellfires.com

*declare that this declaration of conformity is issued under our sole responsibility and belongs to the product below:*

**Product:** Independent gas-fired convection heater  
**Type:** C<sub>11</sub>/C<sub>11</sub>/C<sub>11</sub>  
**Product name:** Bellfires

**Description of the product:**

Horizon Bell XXL 3 CF/LF	Corner Bell XXL 3 L/R CF/LF	Smart Bell 90/70 PF
Horizon Bell XL 3 CF/LF	Corner Bell XL 3 L/R CF/LF	Smart Bell 75/70 PF
Horizon Bell Large 3 CF/LF	Corner Bell Large 3 L/R CF/LF	Smart Bell 80/60 MF
Horizon Bell Medium 3 CF/LF	Corner Bell Medium 3 L/R CF/LF	Smart Bell 75/60 MF
Horizon Bell Small 3 CF/LF	Corner Bell Small 3 L/R CF/LF	Smart Bell 75/55 MF
Horizon Bell XS 3 CF/LF	View Bell Derby 3 CF/LF/PF	Smart Bell 65/60 MF
Horizon Bell Large Tunnel 3 CF/LF	View Bell Topsham 3 CF/LF/PF	Smart Bell 65/55 MF
Horizon Bell Small Tunnel 3 CF/LF	View Bell York 3 CF/LF/PF	Smart Bell 55/60 MF
Vertical Bell Medium 3 CF/LF	View Bell XXL 3 CF/LF	Smart Bell 55/55 MF
Vertical Bell Small 3 CF/LF	View Bell XL 3 CF/LF	Smart Bell 45/60 MF
Vertical Bell Medium Tunnel 3 CF/LF	View Bell Large 3 CF/LF	Smart Bell Panorama 45/45 MF
Vertical Bell Small Tunnel 3 CF/LF	View Bell Medium 3 CF/LF	Smart Bell Panorama 45/59 MF
Derby Large 3 CF/LF/PF	View Bell Small 3 CF/LF	Smart Bell Panorama 73/52 MF
Derby Small 3 CF/LF/PF	View Bell Vertical 3 CF/LF	Box Gas 80 MF
Topsham Large 3 CF/LF/PF	Room Divider Large 3 L/R CF/LF/MF	Box Gas 75 MF
Topsham Small 3 CF/LF	Room Divider Medium 3 L/R CF/LF/MF	Box Gas 65 MF
York Large 3 CF/LF/PF	Classic Bell Small	Box Gas 55 MF
York Small 3 CF/LF/PF	Classic Bell Medium	Box Gas 45 MF
Derby Large Tunnel 3 CF/LF	Smart Bell 80/80 PF	Box Gas Panorama 45/45 MF
Corner Bell Derby 3 L/R CF/LF/PF	Smart Bell 90/80 PF	Box Gas Panorama 45/59 MF
Corner Bell Topsham 3 L/R CF/LF/PF	Smart Bell 75/80 PF	Box Gas Panorama 73/52 MF
Corner Bell York 3 L/R CF/LF/PF	Smart Bell 80/70 PF	

*The object of this declaration is in conformity with the relevant Union harmonisation legislation:*  
 Regulation (EU) 2016/426

*Used relevant harmonised standards or other technical specifications in relation to which conformity is declared:*  
 EN 613:2000

**The notified body:**  
 Kiwa Nederland BV  
 P.O. Box 137  
 NL-7300 AC Apeldoorn

*performed a product verification and issued on* March 29, 2019 *certificate no:* 17GR0140/01

*Signed for and on behalf of:*  
 Danny Bajjens, managing director  
 (name and function)

Bladel; April 1, 2019

Barbas Bellfires B.V.  
 Hallenstraat 17  
 5531 AB Bladel  
 The Netherlands

T +31 (0)497 339 200  
 www.barbasbellfires.com









# **bellfires.**

**Your Bellfires dealer**